



ASHRAE 90.1-2019

nLight® Applications Guide





/ nLight Lighting Controls Platform

It's not just smarter. It's easier.

nLight is a sensor-based, digital lighting controls solution that offers wired and wireless lighting controls that easily connect luminaires, sensors, and other control devices to create a digital network. The nLight platform of products enables ease in specification, installation, and ownership, making it the go-to digital lighting controls platform for specifiers, contractors, and building owners.



/ TABLE OF CONTENTS

- 04 Code Requirements for Common Building Spaces
- 05 How to Use This Guide
- 06 Enclosed Office Solutions
- 08 Open Plan Office Solutions
- 10 Conference Room Solutions
- 12 Classroom Solutions
- 14 Lobby Solutions
- 16 Corridor Solutions
- 18 Restroom Solutions
- 20 Stairwell Solutions
- 21 Gymnasium Solutions
- 22 Warehouse/Storage Solutions
- 23 Parking Area (Garage), Interior
- 24 Exterior Lighting
- 25 nLight Hybrid Networked Lighting Control
- 26 Requirements Overview
- 28 nLight Enabled Luminaires
- 29 Specification Tools



/ ABOUT

About ASHRAE 90.1

ASHRAE 90.1 is an energy code designed to reduce energy consumption. The ASHRAE 90.1–2019 energy code has specific requirements for lighting controls. The use of advanced lighting controls to synchronize light levels with daylight, occupancy, and multi-level control capability are required in order to be compliant.

About This Guide

Acuity Brands® offers the nLight® ASHRAE 90.1–2019 Applications Guide as a reference of typical nLight layouts that help make code compliance quicker and easier. The Acuity Brands Design Services Team is also available to support engineers and contractors with detailed design, submittal, and installation. For additional information, please contact your Acuity Brands Sales Representative.

About nLight

A Single Lighting Controls Platform for Indoor & Outdoor Spaces

nLight® is a distributed intelligence, lighting control platform that offers wired and wireless control products. Luminaires, sensors, switches, and other control devices create one solution that aids in code compliance, energy reduction, and advanced network capabilities. Ideal for any application, small to large, indoor to outdoor, nLight offers lighting controls that scale from one room to an entire floor, from one floor to an entire building, and from one building to an entire campus.

The chart below is an overview of the Code Requirements for Common Building Spaces. Please use this information as a guide. For specific ASHRAE code requirements please refer to the ASHRAE 90.1–2019 code.

Control Requirement*	Code Provision	Code Summary*	Space Type									
			Enclosed Office	Open Plan Office	Conference, Meeting, Multipurpose Room	Classroom, Lecture Hall, Training Room	Lobby	Corridor	Restroom	Stairwell	Gymnasium/Fitness Center	
On-Off Control	Local (i.e., Switch) Control	9.4.1.1[a] There shall be one or more readily accessible manual lighting controls in the space that controls all lighting in the space. Note: Remote locations permitted for reasons of safety or security.	✓	✓	✓	✓	✓	✓	✓	✓	✓	✓
	Manual ON	9.4.1.1[b] None of the lighting in the space shall be automatically turned on.	✓	✓	✓	✓						✓
	Partial Automatic ON	9.4.1.1[c] The general lighting shall be allowed to be turned on automatically to 50% of the lighting power.	(or)	(or)	(or)	(or)						(or)
	Full Automatic ON	9.4.1.1 Automatically controlled spaces are allowed to turn on to full.	✓	✓	✓	✓	✓	✓	✓	✓	✓	✓
	Automatic Partial OFF Via Occupancy Sensor	9.4.1.1[g] The general lighting power shall be automatically reduced by at least 50% within 20 minutes of all occupants leaving the space. Note: Full Off also complies.					✓	✓	✓	✓	✓	
	Automatic Full OFF Via Occupancy Sensor	9.4.1.1[h] All lighting shall be automatically shut off within 20 minutes of all occupants leaving the space.	✓	✓	✓	✓	✓	✓	✓	✓	✓	✓
	Scheduled Shut-off & Off During Non-Business Hours	9.4.1.1[i] 9.4.1.1[j] All lighting shall be automatically shut off during periods when the space is scheduled to be unoccupied using a time-of-day operated control. Note: A signal from another automatic control device or alarm/security system complies.		✓			(or)	(or)	(or)	(or)	✓	✓
Light Level Control	Bi-Level Lighting Control	9.4.1.1[d] Controlled lighting shall have at least one control step between 30% and 70%, or continuous dimming, in addition to full on and full off.	✓	✓	✓	✓					✓	✓
	Automatic Daylight Responsive Controls for Sidelighting/Toplighting	9.4.1.1[e] 9.4.1.1[f] If the general lighting load is 150W or greater in the primary sidelighted or toplighted areas, or 300W or greater in the primary & secondary sidelighted areas, the general lighting in these areas shall be controlled by multi-step or continuous dimming photocontrols.	✓	✓	✓	✓	✓	✓	✓	✓	✓	✓
Additional Controls	Parking Garage Lighting Power Setback	9.4.1.2[b] Lighting power of each luminaire shall be automatically reduced by a minimum of 30% when there is no activity detected within a lighting zone for 20 minutes.										
	Automatic Receptacle (i.e. Plug Load Control)	8.4.2 50% of all receptacles, and 25% of branch circuit feeders installed for modular furniture, shall be automatically turned off by an occupant sensor within 20 minutes of all occupants leaving the space. Note: A time-of-day schedule or a signal from another automatic control device or alarm/security system complies.	✓	✓	✓	✓						
Exterior Control	9.4.1.4 Exterior Lighting Controls	9.4.1.4[a] Daylight shutoff 9.4.1.4[b] Facade and Landscape lighting shutoff 9.4.1.4[c] Lighting setback										

* Note: This summary is for general information purposes only and is provided without any warranty as to accuracy, completeness, or otherwise. The user should read the applicable code sections for more complete and detailed descriptions of code requirements and exceptions and should consult with a professional engineering or other competent advisor before making any decision or taking any action based on this summary.

Warehouse/ Storage Area	Parking Area (Garage), Interior	Exterior Lighting
✓		
✓		
(or)		
✓		
✓		
(or)		
✓	✓	
✓		
✓		
	✓	
		✓

For each space type there will be a wired solution on the left and wireless solution on the right.

Room description

Room layout diagram with controls, fixtures, and wiring

6 ENCLOSED OFFICE: < 250 sq. ft., Windows, nLight Enabled Fixtures

Wired

Wireless

Bill of Materials				Bill of Materials			
Symbol	Qty	Product #	Description	Symbol	Qty	Product #	Description
[Light Fixture]	2	See Note	nLight Wired Enabled Troffer	[Light Fixture]	2	See Note	nLight AIR Enabled Troffer with Sensor Option
[Switch]	1	nWSXA PDT LV DX	Wall Switch Occupancy Sensor with On/Off, Raise/Lower	[Wall Pod]	1	rPODBA DX G2	Battery Powered, On/Off, Raise/Lower WallPod
[Relay Pack]	1	nPP20 PL	Plug Load Relay Pack	[Relay Pack]	1	rPP20 24V EFP G2	Plug Load Relay Pack

OPERATIONAL DETAILS:				ADDITIONAL OPTIONS:			
<p>Light Fixtures:</p> <ul style="list-style-type: none"> All fixtures are dimmable All fixtures can be controlled together or independently Maximum level can be task tuned to any percentage via programming 	<p>Occupancy Control:</p> <ul style="list-style-type: none"> Fixtures must be turned on manually (or optionally can be configured to come on automatically to 50%) Plug-load turns on automatically Fixtures and plug-load turn off automatically when room becomes vacant 	<p>Daylight Control:</p> <ul style="list-style-type: none"> Not required for offices without windows or that have loads <150W in sidelit zones 	<p>Manual Control:</p> <ul style="list-style-type: none"> On/off & raise/lower control of fixtures 	<ul style="list-style-type: none"> Room can be connected to nLight backbone to enable network control or time schedules HVAC control available through system-wide BACnet® interface option on the ECLYPSE® controller Wireless fixture embedded control and occupancy/daylighting sensor options available, please see the fixture specification sheet For emergency lighting control use a power pack with ERE™ option or nLight Enabled Fixture with emergency option 	<p>Note: Contact your local lighting agent for more information on nLight enabled fixtures.</p>	<p>Wire type legend:</p> <ul style="list-style-type: none"> Line Voltage Wires Line Power Feed 	<p>Required list of devices in order to implement room layout design above</p>

www.acuitybrands.com/nLight • 800-535-2465

Operational details describe the functionality provided by the equipment specified in the solution

Additional options that add control capacity beyond code requirements

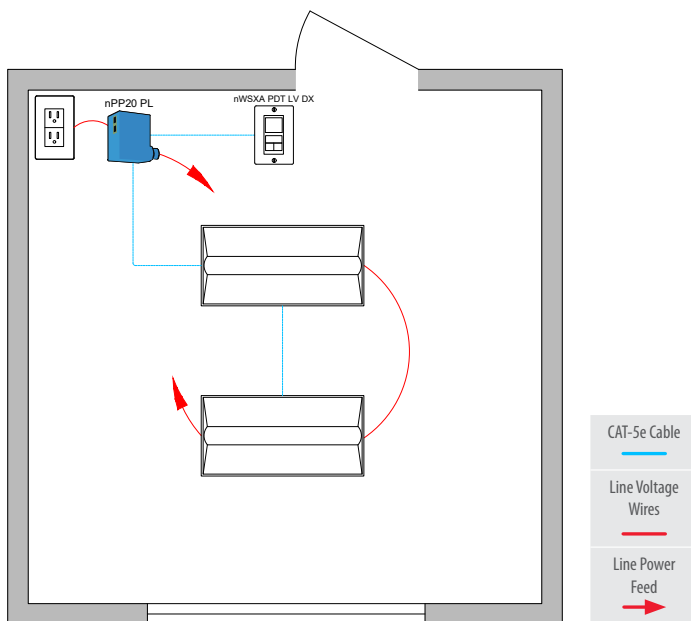

Wired



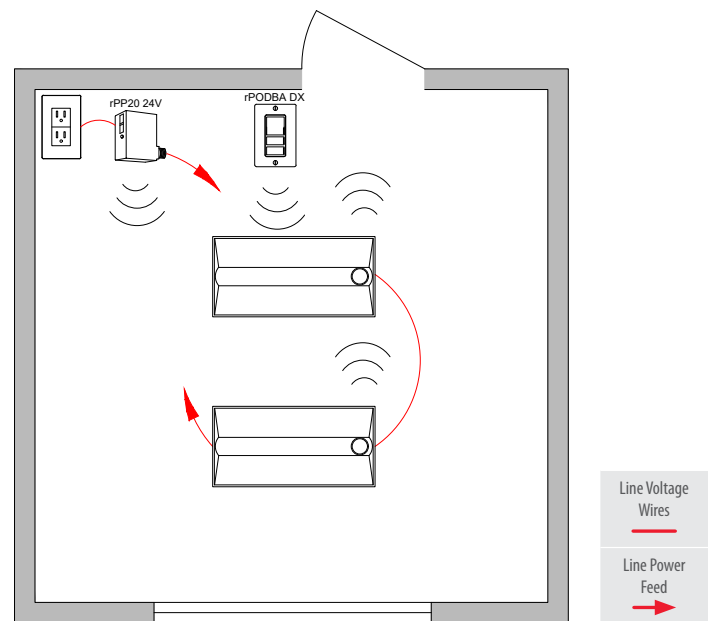

Wireless



Bill of Materials

Symbol	Qty	Product #	Description
	2	See Note	nLight Wired Enabled Troffer
	1	nWSXA PDT LV DX	Wall Switch Occupancy Sensor with On/Off, Raise/Lower
	1	nPP20 PL	Plug Load Relay Pack

Bill of Materials

Symbol	Qty	Product #	Description
	2	See Note	nLight AIR Enabled Troffer with Sensor Option
	1	rPODBA DX G2	Battery Powered, On/Off, Raise/Lower WallPod
	1	rPP20 24V EFP G2	Plug Load Relay Pack

/ OPERATIONAL DETAILS:

Light Fixtures:

- All fixtures are dimmable
- All fixtures can be controlled together or independently
- Maximum level can be task tuned to any percentage via programming

Occupancy Control:

- Fixtures must be turned on manually (or optionally can be configured to come on automatically to 50%)
- Plug-load turns on automatically
- Fixtures and plug-load turn off automatically when room becomes vacant

Daylight Control:

- Not required for offices without windows or that have loads <150W in sidelit zones

Manual Control:

- On/off & raise/lower control of fixtures

/ ADDITIONAL OPTIONS:

- Room can be connected to nLight backbone to enable network control or time schedules
- HVAC control available through system-wide BACnet interface option on the nLight ECLYPSE™ controller
- Wireless fixture embedded control and occupancy/daylighting sensor options available, please see the fixture specification sheet
- For emergency lighting control use a power pack with ER/EM option or nLight Enabled Fixture with emergency option

Note: Contact your local lighting agent for more information on nLight enabled fixtures.

Wired

Wireless

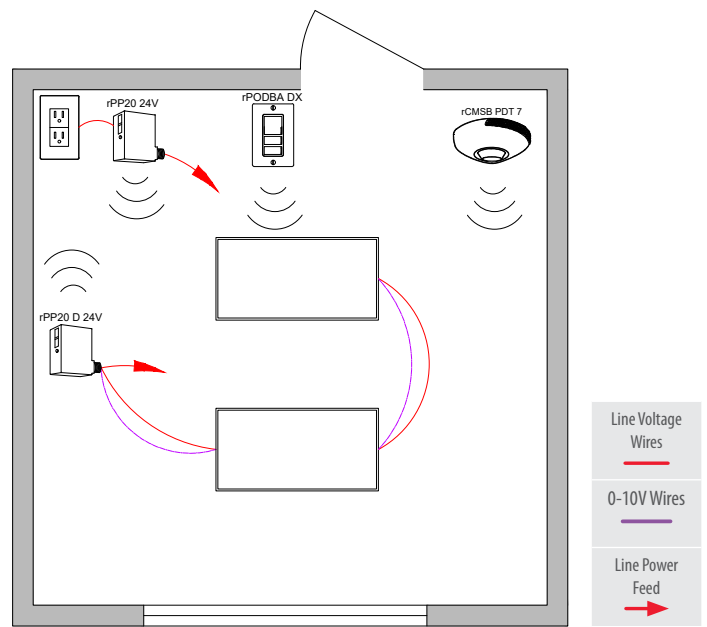
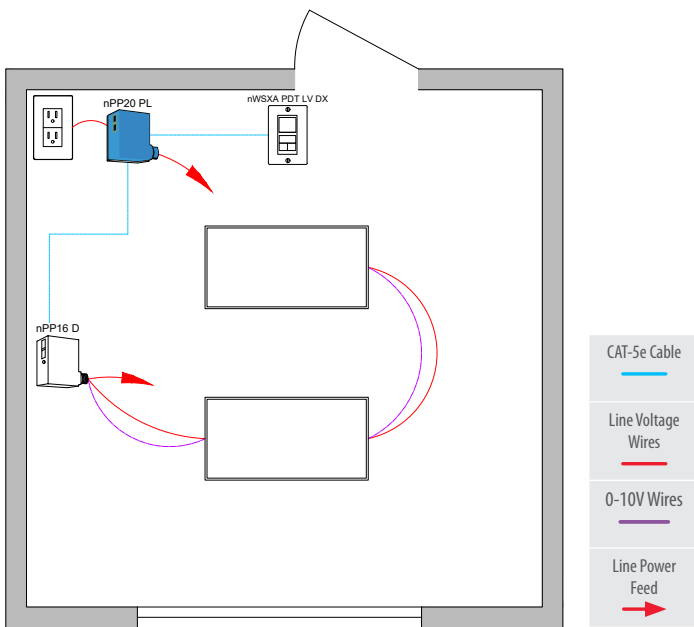

Bill of Materials

Symbol	Qty	Product #	Description
	1	nPP16 D EFP	Relay Pack with 0-10V Dimming Output
	1	nWSXA PDT LV DX	Wall Switch Occupancy Sensor with On/Off, Raise/Lower
	1	nPP20 PL	Plug Load Relay Pack

Bill of Materials

Symbol	Qty	Product #	Description
	1	rPP20 D 24V EFP G2	Relay Pack with 0-10V Dimming Output
	1	rPODBA DX G2	Battery Powered, On/Off, Raise/Lower WallPod
	1	rCMSB PDT 7 G2	Battery Powered Occupancy and Daylight Sensor
	1	rPP20 24V EFP G2	Plug Load Relay Pack

OPERATIONAL DETAILS:

Light Fixtures:

- All fixtures are dimmable
- All fixtures are controlled together
- Maximum level can be task tuned to any percentage via programming

Occupancy Control:

- Fixtures must be turned on manually (or optionally can be configured to come on automatically to 50%)
- Plug-load turns on automatically
- Fixtures and plug-load turn off automatically when room becomes vacant

Daylight Control:

- Not required for offices without windows or that have loads <150W in sidelit zone

Manual Control:

- On/off & raise/lower control of fixtures

ADDITIONAL OPTIONS:

- Room can be connected to nLight backbone to enable network control or time schedules
- HVAC control available through system-wide BACnet interface option on the nLight ECLYPSE™ controller
- For emergency lighting control use a power pack with ER/EM option or nLight Enabled Fixture with emergency option

Wired

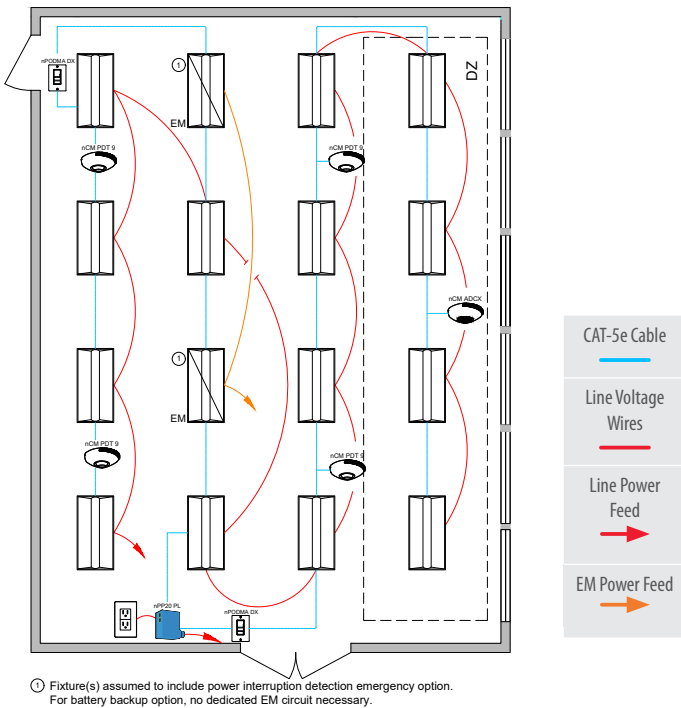

Wireless

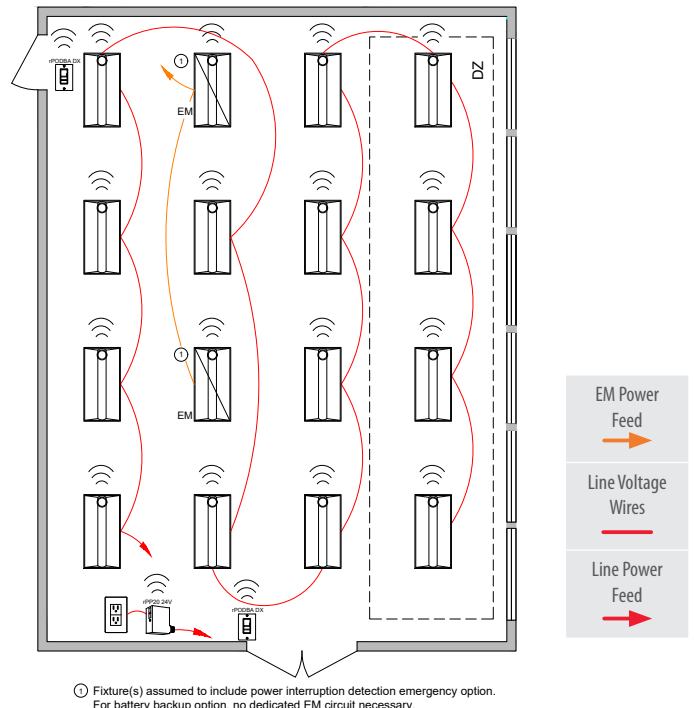

Bill of Materials

Symbol	Qty	Product #	Description
	14	See Note	nLight Wired Enabled Troffer
	2	See Note	nLight Wired Enabled Troffer with Battery Option
	2	nPODMA DX	On/Off, Raise/Lower WallPod
	4	nCM PDT 9 RJB	Occupancy Sensor
	1	nCM ADCX RJB	Daylight Sensor
	1	nPP20 PL	Plug Load Relay Pack

Bill of Materials

Symbol	Qty	Product #	Description
	14	See Note	nLight AIR Enabled Troffer with Sensor Option
	2	See Note	nLight AIR Enabled Troffer with Sensor and EM Option
	2	rPODBA DX G2	Battery Powered, On/Off, Raise/Lower WallPod
	1	rPP20 24V EFP G2	Plug Load Relay Pack

/ OPERATIONAL DETAILS:

Light Fixtures:

- All fixtures are dimmable
- All fixtures are controlled together or independently
- Maximum level can be task tuned to any percentage via programming

Occupancy Control:

- Fixtures must be turned on manually (or optionally can be configured to come on automatically to 50%)
- Plug-load turns on automatically
- Fixtures and plug-load turn off automatically when room becomes vacant

Daylight Control:

- Smooth continuous dimming
- Custom grouping of fixtures into separate daylight zones (max. number zones = number of fixtures)
- Not required for offices without windows or that have loads <150W in sidelit zones

Manual Control:

- On/off & raise/lower control of fixtures

/ ADDITIONAL OPTIONS:

- Room can be connected to nLight backbone to enable network control or time schedules
- HVAC control available through system-wide BACnet interface option on the nLight ECLYPSE™ controller
- Wireless fixture embedded control and occupancy/daylighting sensor options available, please see the fixture specification sheet
- For emergency lighting control use a power pack with ER/EM option or nLight Enabled Fixture with emergency option

Note: Contact your local lighting agent for more information on nLight enabled fixtures.

Wired

Wireless

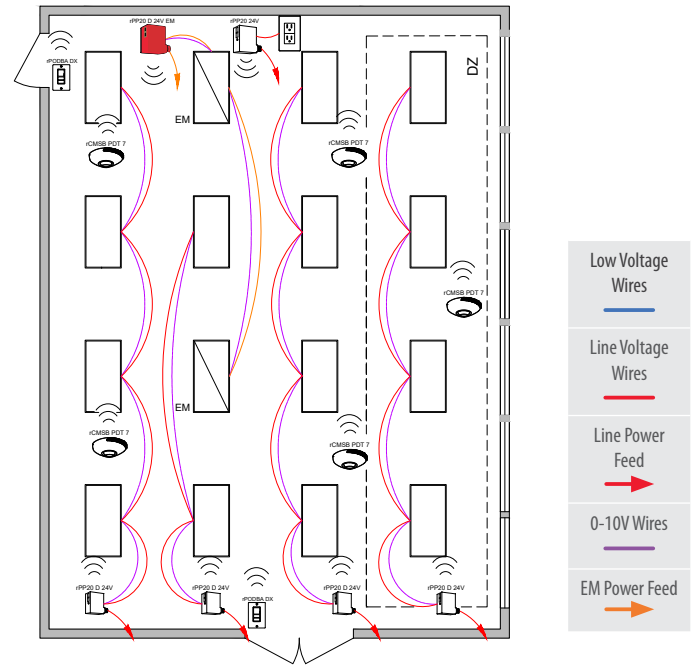
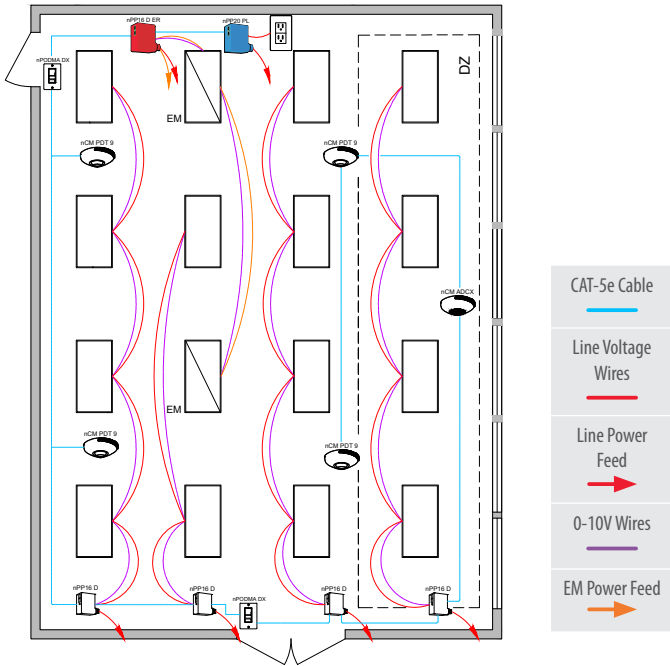

Bill of Materials

Symbol	Qty	Product #	Description
	4	nPP16 D EFP	Relay Pack with 0-10V Dimming Output
	1	nPP16 D ER EFP	Emergency Relay Pack with 0-10V Dimming Output
	2	nPODMA DX	On/Off, Raise/Lower WallPod
	4	nCM PDT 9 RJB	Occupancy Sensor
	1	nCM ADCX RJB	Daylight Sensor
	1	nPP20 PL	Plug Load Relay Pack

Bill of Materials

Symbol	Qty	Product #	Description
	4	rPP20 D 24V EFP G2	Relay Pack with 0-10V Dimming Output
	1	rPP20 D 24V EM EFP G2	Emergency Relay Pack with 0-10V Dimming Output
	2	rPODBA DX G2	Battery Powered, On/Off, Raise/Lower WallPod
	5	rCMSB PDT 7 G2	Battery Powered Occupancy and Daylight Sensor
	1	rPP20 24V EFP G2	Plug Load Relay Pack

OPERATIONAL DETAILS:

Light Fixtures:

- All fixtures are dimmable
- Each row controlled independently
- Maximum level can be task tuned to any percentage via programming

Occupancy Control:

- Fixtures must be turned on manually (or optionally can be configured to come on automatically to 50%)
- Plug-load turns on automatically
- Fixtures and plug-load turn off automatically when room becomes vacant

Daylight Control:

- Smooth continuous dimming
- Daylight zones defined by rows
- Not required for offices without windows or that have loads <150W in sidelit zones

Manual Control:

- On/off & raise/lower control of fixtures

ADDITIONAL OPTIONS:

- Room can be connected to nLight backbone to enable network control or time schedules
- HVAC control available through system-wide BACnet interface option on the nLight ECLYPSE™ controller
- For emergency lighting control use a power pack with ER/EM option or nLight Enabled Fixture with emergency option

Wired

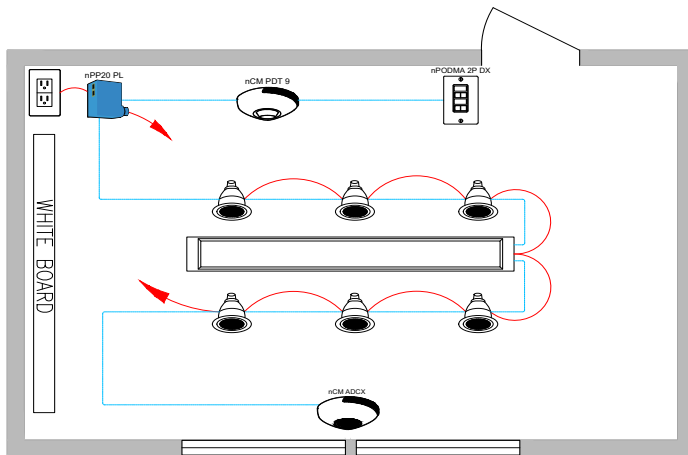

CAT-5e Cable

Line Voltage Wires

Line Power Feed

Wireless

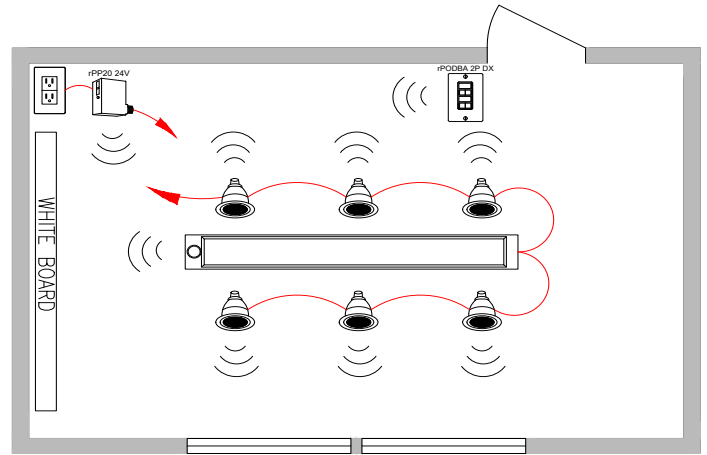

Line Voltage Wires

Line Power Feed

Bill of Materials

Symbol	Qty	Product #	Description
	1	See Note	nLight Wired Enabled Linear Fixture
	6	See Note	nLight Wired Enabled Downlight Fixture
	1	nPODMA 2P DX	2-Pole, On/Off, Raise/Lower WallPod
	1	nCM PDT 9 RJB	Occupancy Sensor
	1	nCM ADCX RJB	Daylight Sensor
	1	nPP20 PL	Plug Load Relay Pack

Bill of Materials

Symbol	Qty	Product #	Description
	1	See Note	nLight AIR Enabled Linear Fixture with Sensor Option
	6	See Note	nLight AIR Enabled Downlight Fixture
	1	rPODBA 2P DX G2	Battery Powered, 2-Pole, On/Off, Raise/Lower WallPod
	1	rPP20 24V EFP G2	Plug Load Relay Pack

/ OPERATIONAL DETAILS:

Light Fixtures:

- All fixtures are dimmable
- Maximum level can be task tuned to any percentage via programming
- A/V zone can be programmed to control two fixtures in front of the whiteboard

Occupancy Control:

- Fixtures must be turned on manually (or optionally can be configured to come on automatically to 50%)
- Plug-load turns on automatically
- Fixtures and plug-load turn off automatically when room becomes vacant

Daylight Control:

- Smooth continuous dimming
- Custom grouping of fixtures into separate daylight zones (max number zones = number of fixtures)
- Not required for areas without windows or that have loads <150w in sidelit zones

Manual Control:

- On/off & raise lower control of two zones of fixtures

/ ADDITIONAL OPTIONS:

- Room can be connected to nLight backbone to enable network control or time schedules
- HVAC control available through system-wide BACnet interface option on the nLight ECLYPSE™ controller
- Wireless fixture embedded control and occupancy/daylighting sensor options available, please see the fixture specification sheet
- For emergency lighting control use a power pack with ER/EM option or nLight Enabled Fixture with emergency option

Note: Contact your local lighting agent for more information on nLight enabled fixtures.

Wired

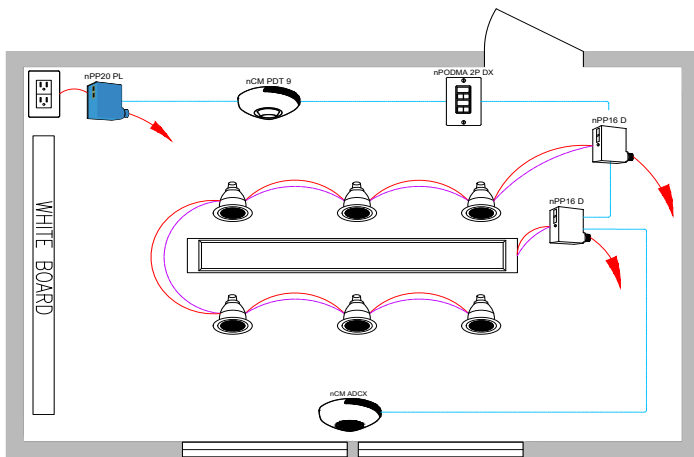

Wireless

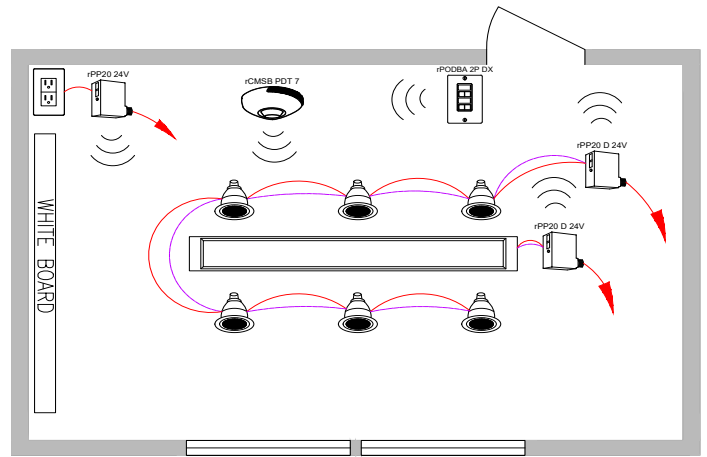

Bill of Materials

Symbol	Qty	Product #	Description
	2	nPP16 D EFP	Relay Pack with 0-10V Dimming Output
	1	nPODMA 2P DX	2-Pole, On/Off, Raise/Lower WallPod
	1	nCM PDT 9 RJB	Occupancy Sensor
	1	nCM ADCX RJB	Daylight Sensor
	1	nPP20 PL	Plug Load Relay Pack

Bill of Materials

Symbol	Qty	Product #	Description
	2	rPP20 D 24V EFP G2	Relay Pack with 0-10V Dimming Output
	1	rPODBA 2P DX G2	Battery Powered, 2-Pole, On/Off, Raise/Lower WallPod
	1	rCMSB PDT 7 G2	Battery Powered Occupancy and Daylight Sensor
	1	rPP20 24V EFP G2	Plug Load Relay Pack

OPERATIONAL DETAILS:

Light Fixtures:

- All fixtures are dimmable
- Maximum level can be task tuned to any percentage via programming

Occupancy Control:

- Fixtures must be turned on manually (or optionally can be configured to come on automatically to 50%)
- Plug-load turns on automatically
- Fixtures and plug-load turn off automatically when room becomes vacant

Daylight Control:

- Smooth continuous dimming
- Daylight zones defined by rows
- Not required for areas without windows or that have loads <150W in sidelit zones

Manual Control:

- On/off & raise lower control of two zones of fixtures

ADDITIONAL OPTIONS:

- Room can be connected to nLight backbone to enable network control or time schedules
- HVAC control available through system-wide BACnet interface option on the nLight ECLYPSE™ controller
- For emergency lighting control use a power pack with ER/EM option or nLight Enabled Fixture with emergency option

Wired

Wireless

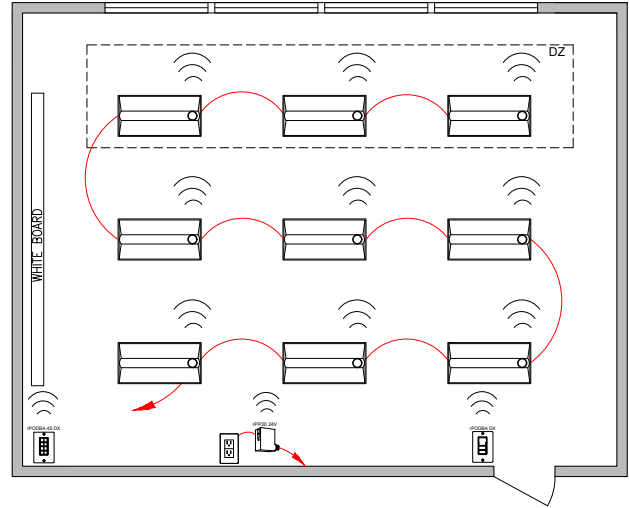
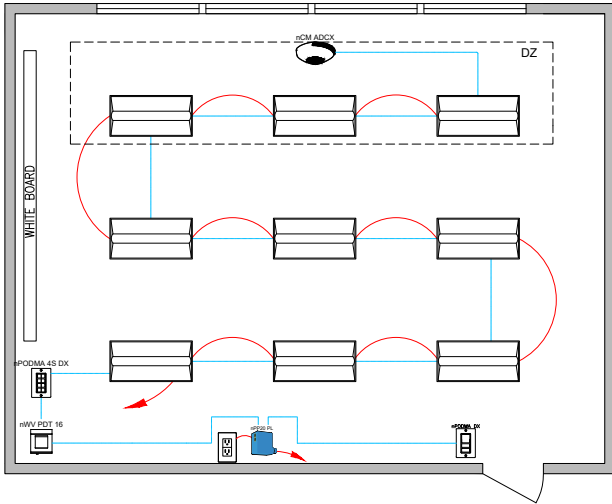

Bill of Materials

Symbol	Qty	Product #	Description
	9	See Note	nLight Wired Enabled Troffer
	1	nPODMA DX	On/Off, Raise/Lower WallPod
	1	nWV PDT 16	Dual Technology Wide View Occupancy Sensor
	1	nPODMA 4S DX	Teacher Station — 4 Scene Control with Master On/Off & Raise/Lower
	1	nCM ADCX RJB	Daylight Sensor
	1	nPP20 PL	Plug Load Relay Pack

Bill of Materials

Symbol	Qty	Product #	Description
	9	See Note	nLight AIR Enabled Troffer with Sensor Option
	1	rPODBA DX G2	Battery Powered, On/Off, Raise/Lower WallPod
	1	rPODBA 4S DX G2	Teacher Station — Battery Powered 4 Scene Control with Master On/Off & Raise/Lower
	1	rPP20 24V EFP G2	Plug Load Relay Pack

/ OPERATIONAL DETAILS:

Light Fixtures:

- All fixtures are dimmable
- All fixtures are controlled together or independently
- Maximum level can be task tuned to any percentage via programming

Occupancy Control:

- Fixtures must be turned on manually (or optionally can be configured to some on automatically to 50%)
- Plug-load turns on automatically
- Fixtures and plug-load turn off automatically when room becomes vacant

Daylight Control:

- Smooth continuous dimming
- Custom grouping of fixtures into separate daylight zones (max number zones = number of fixtures)
- Not required for areas without windows or that have loads <150W in sidelit zones

Manual Control:

- On/off & raise/lower control of entire room
- Teacher station with 4 preset scenes

/ ADDITIONAL OPTIONS:

- Room can be connected to nLight backbone to enable network control or time schedules
- HVAC control available through system-wide BACnet interface option on the nLight ECLYPSE™ controller
- Wireless fixture embedded control and occupancy/daylighting sensor options available, please see the fixture specification sheet
- For emergency lighting control use a power pack with ER/EM option or nLight Enabled Fixture with emergency option

Note: Contact your local lighting agent for more information on nLight enabled fixtures.

Wired

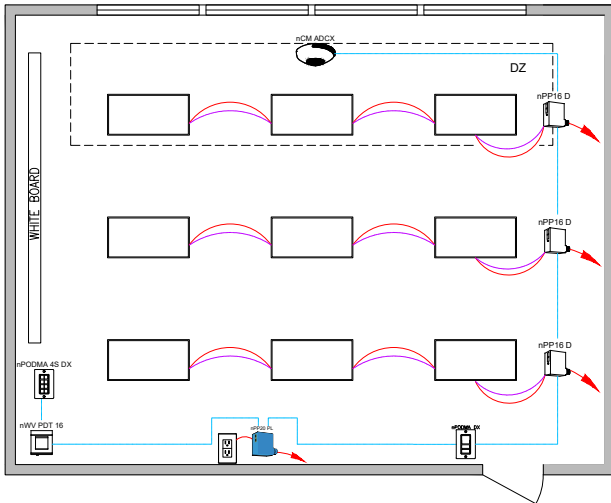

Wireless

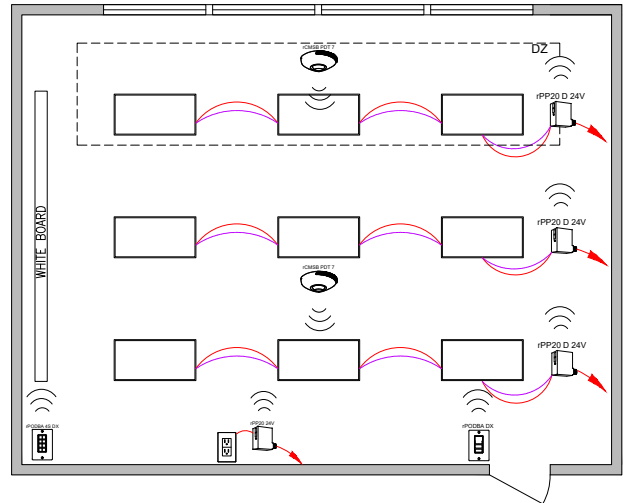

Bill of Materials

Symbol	Qty	Product #	Description
	3	nPP16 D EFP	Relay Module with 0-10V Dimming Output
	1	nPODMA DX	On/Off, Raise/Lower WallPod
	1	nWV PDT 16	Dual Technology Wide View Occupancy Sensor
	1	nPODMA 4S DX	Teacher Station — 4 Scene Control with Master On/Off & Raise/Lower
	1	nCM ADCX RJB	Daylight Sensor
	1	nPP20 PL	Plug Load Relay Pack

Bill of Materials

Symbol	Qty	Product #	Description
	3	rPP20 D 24V EFP G2	Relay Pack with 0-10V Dimming Output
	1	rPODBA DX G2	Battery Powered, On/Off, Raise/Lower WallPod
	2	rCMSB PDT 7 G2	Battery Powered Occupancy and Daylight Sensor
	1	rPODBA 4S DX G2	Teacher Station — Battery Powered 4 Scene Control with Master On/Off & Raise/Lower
	1	rPP20 24V EFP G2	Plug Load Relay Pack

OPERATIONAL DETAILS:

Light Fixtures:

- All fixtures are dimmable
- Each row can be controlled independently
- Maximum level can be task tuned to any percentage via programming

Occupancy Control:

- Fixtures must be turned on manually (or optionally can be configured to come on automatically to 50%)
- Plug-load turns on automatically
- Fixtures and plug-load turn off automatically when room becomes vacant

Daylight Control:

- Smooth continuous dimming
- Daylight zones defined by rows
- Not required for areas without windows or that have loads <150W in sidelit zones

Manual Control:

- Master on/off & raise/lower control of entire room
- Teacher station with 4 preset scenes

ADDITIONAL OPTIONS:

- Room can be connected to nLight backbone to enable network control or time schedules
- HVAC control available through system-wide BACnet interface option on the nLight ECLYPSE™ controller
- For emergency lighting control use a power pack with ER/EM option or nLight Enabled Fixture with emergency option

Wired

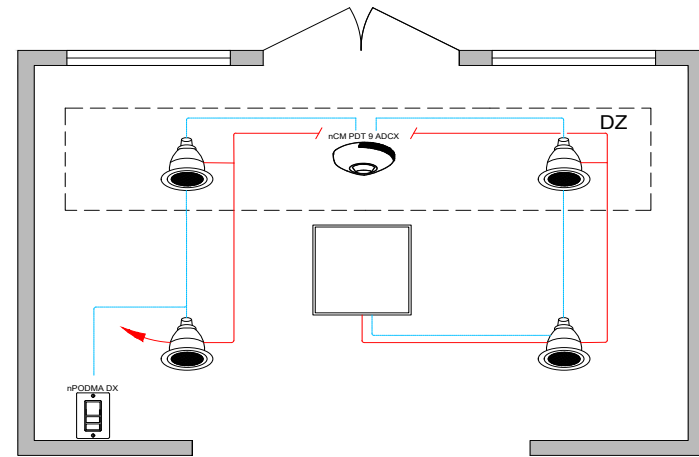

Wireless

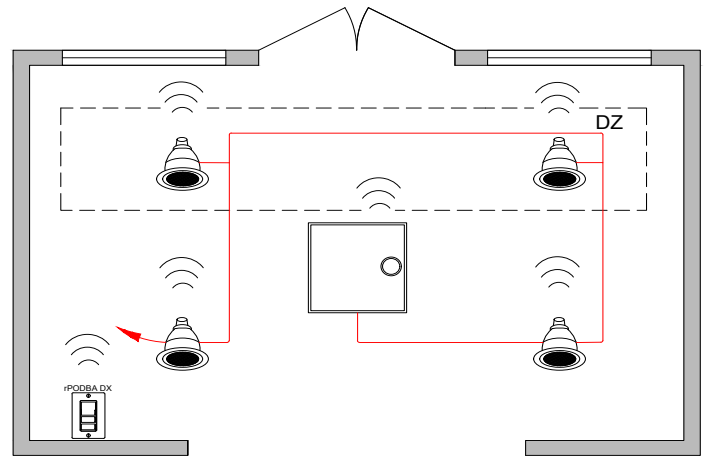

Bill of Materials

Symbol	Qty	Product #	Description
	4	See Notes	nLight Wired Enabled Downlight
	1	See Notes	nLight Wired Enabled Troffer
	1	nPODMA DX	On/Off, Raise/Lower WallPod
	1	nCM PDT 9 ADCX RJB	Occupancy and Daylight Sensor

Bill of Materials

Symbol	Qty	Product #	Description
	4	See Notes	nLight AIR Enabled Downlight
	1	See Notes	nLight AIR Enabled Troffer with Sensor Option
	1	rPODBA DX G2	Battery Powered, On/Off, Raise/Lower WallPod

OPERATIONAL DETAILS:

Light Fixtures:

- All fixtures are dimmable
- All fixtures are controlled together or independently
- Maximum level can be task tuned to any percentage via programming

Occupancy Control:

- Fixtures automatically go to full bright when occupied
- Fixtures automatically turn off when room becomes vacant

Daylight Control:

- Smooth continuous dimming
- Custom grouping of fixtures into separate daylight zones (max number zones = number of fixtures)
- Not required for areas without windows or that have loads <150W in sidelit zones

Manual Control:

- On/off & raise/lower control of fixtures

ADDITIONAL OPTIONS:

- Room can be connected to nLight backbone to enable network control or time schedules
- HVAC control available through system-wide BACnet interface option on the nLight ECLYPSE™ controller
- Wireless fixture embedded control and occupancy/daylighting sensor options available, please see the fixture specification sheet
- For emergency lighting control use a power pack with ER/EM option or nLight Enabled Fixture with emergency option

Note: Contact your local lighting agent for more information on nLight enabled fixtures.

Wired

Wireless

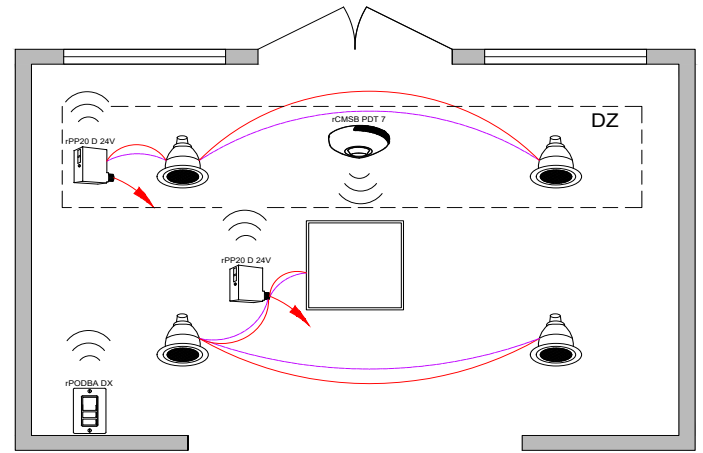
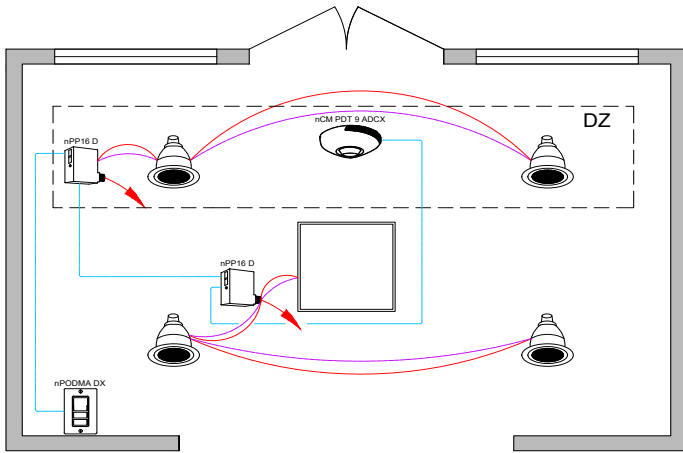

Bill of Materials

Bill of Materials

Symbol	Qty	Product #	Description
	2	nPP16 D EFP	Relay Pack with 0-10V Dimming Output
	1	nPODMA DX	On/Off, Raise/Lower WallPod
	1	nCM PDT 9 ADCX RJB	Occupancy and Daylight Sensor

Symbol	Qty	Product #	Description
	2	rPP20 D 24V EFP G2	Relay Pack with 0-10V Dimming Output
	1	rPODBA DX G2	Battery Powered, On/Off, Raise/Lower WallPod
	1	rCMSB PDT 7 G2	Battery Powered Occupancy and Daylight Sensor

OPERATIONAL DETAILS:

ADDITIONAL OPTIONS:

Light Fixtures:

- All fixtures are dimmable
- Maximum level can be task tuned to any percentage via programming

Occupancy Control:

- Fixtures automatically go to full bright when occupied
- Fixtures automatically turn off when room becomes vacant

Daylight Control:

- Smooth continuous dimming
- Daylight zones defined by relay module wiring
- Not required for areas without windows or that have loads <150W in sidelit zones

Manual Control:

- On/off & raise/lower control of fixtures

- Room can be connected to nLight backbone to enable network control or time schedules
- HVAC control available through system-wide BACnet interface option on the nLight ECLYPSE™ controller
- For emergency lighting control use a power pack with ER/EM option or nLight Enabled Fixture with emergency option

Wired

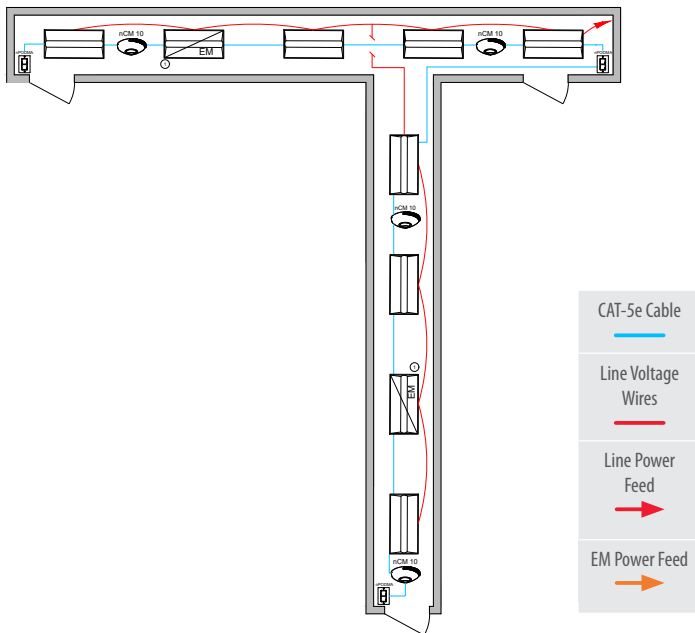

- ① Some nLight enabled EM fixtures require a normal sense line connection. Wiring shown assumes battery backup emergency option. See fixture spec sheets for details.

Bill of Materials

Symbol	Qty	Product #	Description
	7	See Note	nLight Wired Enabled Troffer with Sensor Option
	2	See Note	nLight Wired Enabled Troffer with Battery Option
	3	nPODMA	On/Off WallPod
	4	nCM 10 RJB	Occupancy Sensor

/ OPERATIONAL DETAILS:

Light Fixtures:

- All fixtures are dimmable
- All fixtures are controlled together or independently
- Maximum level can be task tuned to any percentage via programming

Occupancy Control:

- Fixtures automatically go to full bright when occupied
- Fixtures automatically turn off or optionally can be configured to drop to low dim setting when space becomes vacant

Daylight Control:

- Not required for areas without windows or that have loads <150W in sidelit zones

Manual Control:

- On/off control of fixtures

Note: Contact your local lighting agent for more information on nLight enabled fixtures.

Wireless

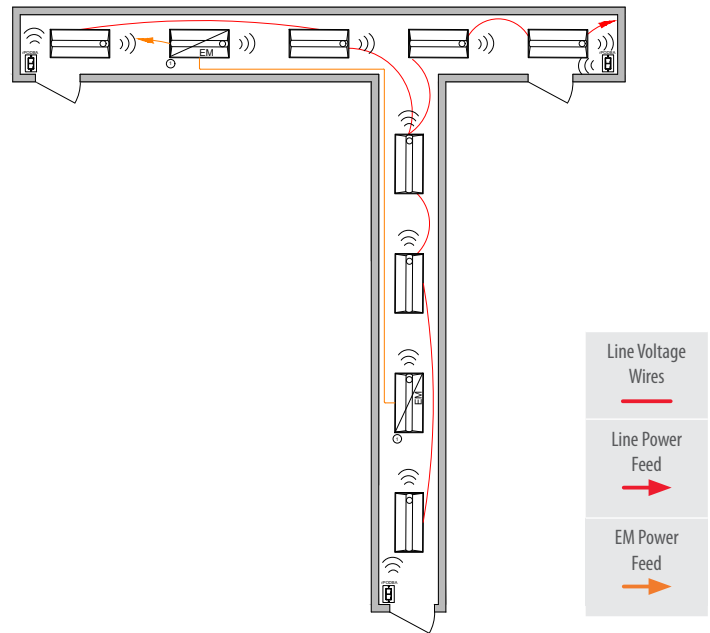

- ① Fixture(s) assumed to include power interruption detection emergency option. For battery backup option, no dedicated EM circuit necessary.

Bill of Materials

Symbol	Qty	Product #	Description
	7	See Note	nLight AIR Enabled Troffer with Sensor Option
	2	See Note	nLight AIR Enabled Troffer with Sensor and EM Option
	3	rPODBA G2	Battery Powered, On/Off WallPod

/ ADDITIONAL OPTIONS:

- Room can be connected to nLight backbone to enable network control or time schedules
- HVAC control available through system-wide BACnet interface option on the nLight ECLYPSE™ controller
- Wireless fixture embedded control and occupancy/daylighting sensor options available, please see the fixture specification sheet
- For emergency lighting control use a power pack with ER/EM option or nLight Enabled Fixture with emergency option

Wired

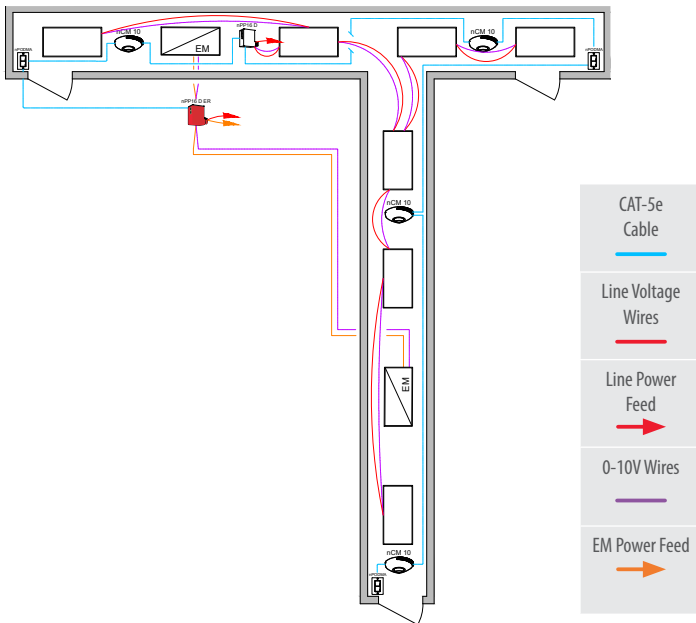

Wireless

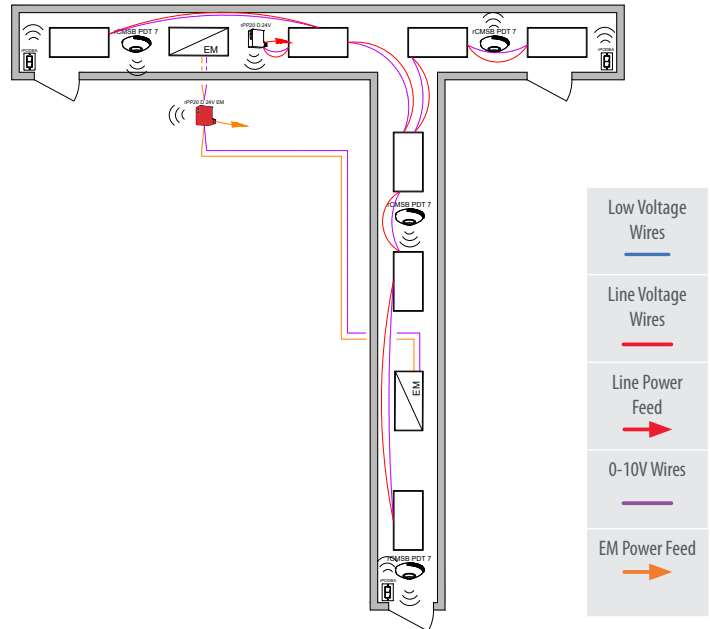

Bill of Materials

Symbol	Qty	Product #	Description
	1	nPP16 D EFP	Relay Pack with 0-10V Dimming Output
	1	nPP16 D ER EFP	Emergency Relay Pack with 0-10V Dimming Output
	4	nCM 10 RJB	Occupancy Sensor
	3	nPODMA	On/Off WallPod

Bill of Materials

Symbol	Qty	Product #	Description
	1	rPP20 D 24V EFP G2	Relay Pack with 0-10V Dimming Output
	1	rPP20 D 24V EM EFP G2	Emergency Relay Pack with 0-10V Dimming Output
	4	rCMSB PDT 7 G2	Battery Powered Occupancy Sensor
	3	rPODBA G2	Battery Powered, On/Off WallPod

/ OPERATIONAL DETAILS:

Light Fixtures:

- All fixtures are dimmable
- Maximum level can be task tuned to any percentage via programming

Occupancy Control:

- Fixtures automatically go to full bright when occupied
- Fixtures automatically turn off or optionally can be configured to drop to low dim setting when space becomes vacant

Daylight Control:

- Not required for areas without windows or that have loads <150W in sidelit zones

Manual Control:

- On/off control of fixtures
- If switch poses a safety concern, optionally can be programmed for 'on' only.

/ ADDITIONAL OPTIONS:

- Room can be connected to nLight backbone to enable network control or time schedules
- HVAC control available through system-wide BACnet interface option on the nLight ECLYPSE™ controller
- For emergency lighting control use a power pack with ER/EM option or nLight Enabled Fixture with emergency option

Wired

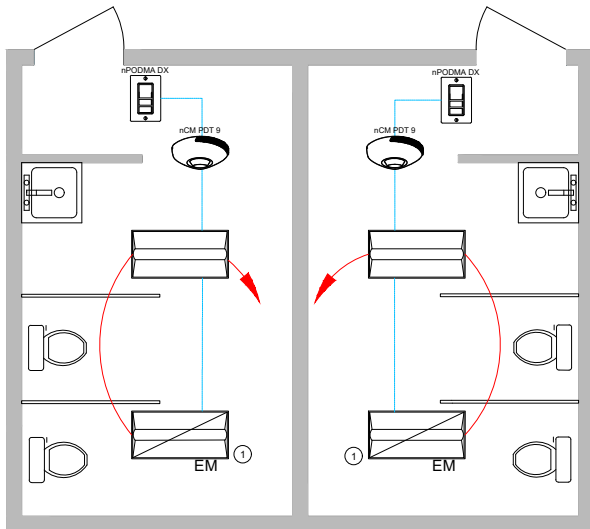

① Some nLight enabled EM fixtures require a normal sense line connection. Wiring shown assumes battery backup emergency option. See fixture spec sheets for details.



Wireless

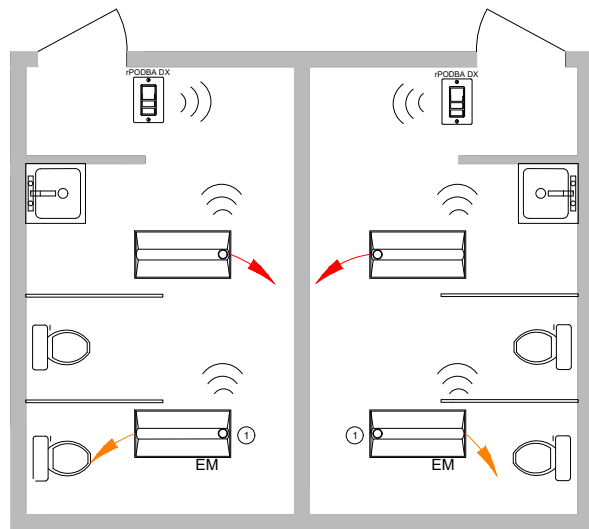

① Fixture(s) assumed to include power interruption detection emergency option. For battery backup option, no dedicated EM circuit necessary.



Bill of Materials

Symbol	Qty	Product #	Description
	2	See Note	nLight Wired Enabled Troffer
	2	See Note	nLight Wired Enabled Troffer with Battery Option
	2	nPODMA DX	On/Off, Raise/Lower WallPod
	2	nCM PDT 9 RJB	Occupancy Sensor

Bill of Materials

Symbol	Qty	Product #	Description
	2	See Note	nLight AIR Enabled Troffer with Sensor Option
	2	See Note	nLight AIR Enabled Troffer with Sensor and EM Option
	2	nPODBA DX G2	Battery Powered, On/Off, Raise/Lower WallPod

OPERATIONAL DETAILS:

Light Fixtures:

- All fixtures are dimmable
- All fixtures are controlled together or independently (per room)
- Maximum level can be task tuned to any percentage via programming

Occupancy Control:

- Fixtures automatically go to full bright when occupied (or optionally can be configured to come on automatically to 50%)
- Fixtures automatically turn off or optionally can be configured to drop to low dim setting when space becomes vacant

Manual Control:

- On/off & raise/lower control of fixtures
- If switch poses safety concerns, optionally can be programmed for "on only"

ADDITIONAL OPTIONS:

- Room can be connected to nLight backbone to enable network control or time schedules
- HVAC control available through system-wide BACnet interface option on the nLight ECLYPSE™ controller
- Fixture embedded control and occupancy/daylighting sensor options available, please see the fixture specification sheet
- For emergency lighting control use a power pack with ER/EM option or nLight Enabled Fixture with emergency option

Note: Contact your local lighting agent for more information on nLight enabled fixtures.

Wired

Wireless

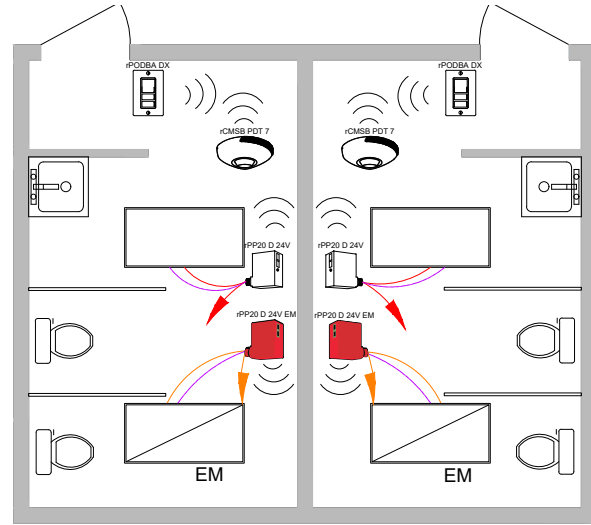
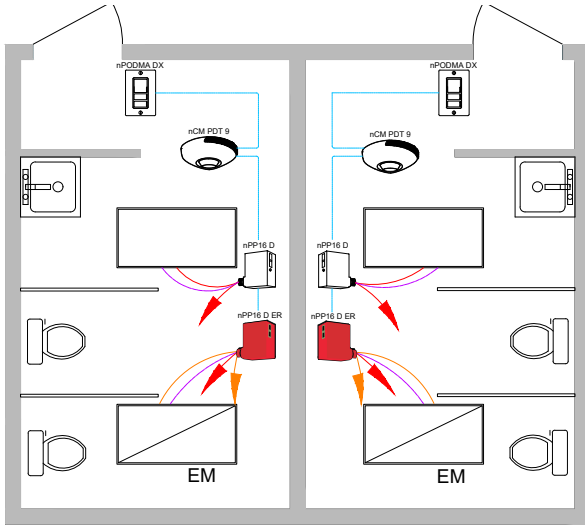

Bill of Materials

Symbol	Qty	Product #	Description
	2	nPP16 D EFP	Relay Pack with 0-10V Dimming Output
	2	nPP16 D ER EFP	Emergency Module with 0-10V Dimming Output
	2	nPODMA DX	On/Off & Raise/Lower WallPod
	2	nCM PDT 9 RJB	Occupancy Sensor

Bill of Materials

Symbol	Qty	Product #	Description
	2	rPP20 D 24V EFP G2	Relay Pack with 0-10V Dimming Output
	2	rPP20 D 24V EM EFP G2	Emergency Relay Pack with 0-10V Dimming Output
	2	rPODBA DX G2	Battery Powered, On/Off & Raise/Lower WallPod
	2	rCMSB PDT 7 G2	Battery Powered Occupancy Sensor

OPERATIONAL DETAILS:

Light Fixtures:

- All fixtures are dimmable
- Maximum level can be task tuned to any percentage via programming

Occupancy Control:

- Fixtures automatically go to full bright when occupied (or optionally can be configured to come on automatically to 50%)
- Fixtures automatically turn off or optionally can be configured to drop to low dim setting when space becomes vacant

Manual Control:

- On/off & raise/lower control of fixtures
- If switch poses safety concerns, optionally can be programmed for "on only"

ADDITIONAL OPTIONS:

- Room can be connected to nLight backbone to enable network control or time schedules
- HVAC control available through system-wide BACnet interface option on the nLight ECLYPSE™ controller
- Wireless fixture embedded control and occupancy/daylighting sensor options available, please see the fixture specification sheet
- For emergency lighting control use a power pack with ER/EM option or nLight Enabled Fixture with emergency option

Wireless with nLight Enabled Fixtures

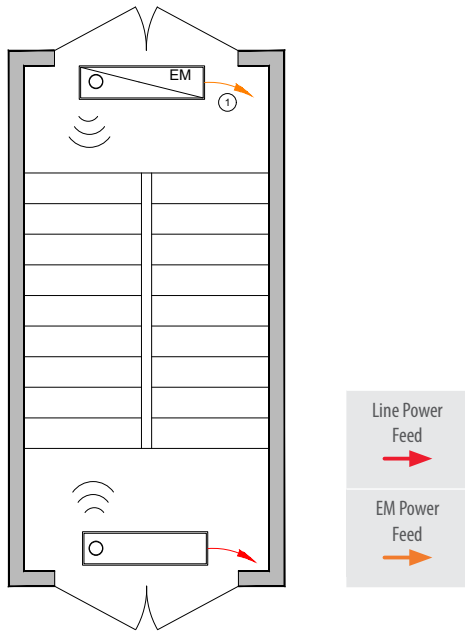

① Fixture(s) assumed to include power interruption detection emergency option. For battery backup option, no dedicated EM circuit necessary.

Wireless with 0-10V Dimming Fixtures

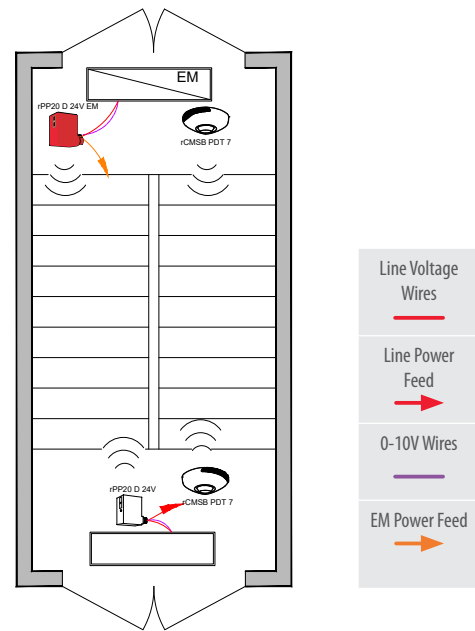

Bill of Materials

Symbol	Qty	Product #	Description
	1	See Note	nLight AIR Enabled Fixture with Sensor Option
	1	See Note	nLight AIR Enabled Fixture with Sensor and EM Option

Bill of Materials

Symbol	Qty	Product #	Description
	1	rPP20 D 24V EFP G2	Relay Pack with 0-10V Dimming Output
	1	rPP20 D 24V EM EFP G2	Emergency Relay Pack with 0-10V Dimming Output
	2	rCMSB PDT 7 G2	Battery Powered Occupancy Sensor

OPERATIONAL DETAILS:

Light Fixtures:

- All fixtures are dimmable
- Maximum level can be task tuned to any percentage via programming

Occupancy Control:

- Fixtures automatically go to full bright when occupied
- Fixtures automatically turn off or optionally can be configured to drop to low dim setting when space becomes vacant

Manual Control:

- Safety may preclude the use of a manual control in these areas

Note: Contact your local lighting agent for more information on nLight enabled fixtures.

ADDITIONAL OPTIONS:

- Room can be connected to nLight backbone to enable network control or time schedules
- HVAC control available through system-wide BACnet interface option on the nLight ECLYPSE™ controller
- Wireless fixture embedded control and occupancy/daylighting sensor options available, please see the fixture specification sheet
- For emergency lighting control use a power pack with ER/EM option or nLight Enabled Fixture with emergency option

Wireless with nLight Enabled Fixtures

Wireless with 0-10V Dimming Fixtures

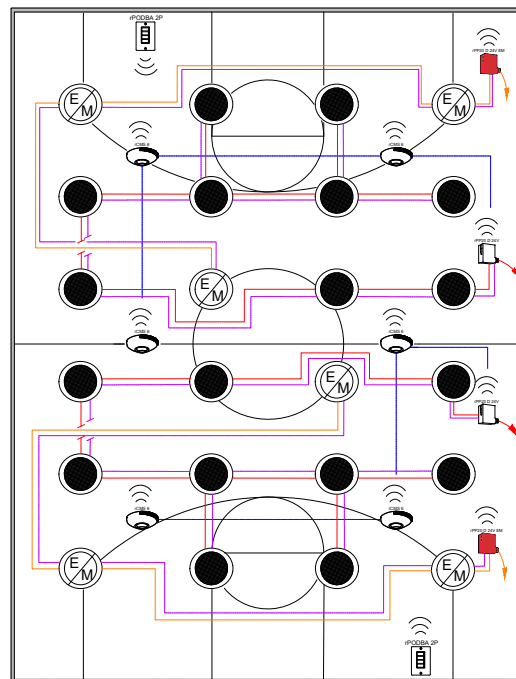
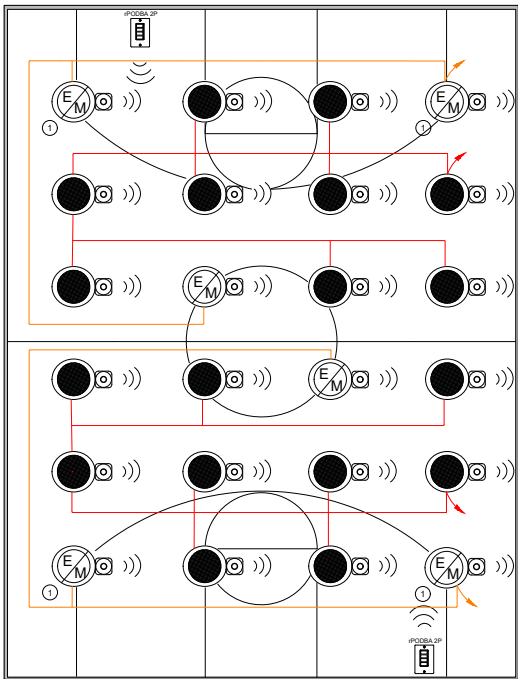

① Fixture(s) assumed to include power interruption detection emergency option. For battery backup option, no dedicated EM circuit necessary.



Bill of Materials

Symbol	Qty	Product #	Description
	18	See Notes	nLight AIR Enabled Fixture with Sensor Option
	6	See Notes	nLight AIR Enabled Fixture with Sensor and EM Option
	2	rPODBA 2P G2	Battery Powered, 2-Pole, On/Off WallPod

Bill of Materials

Symbol	Qty	Product #	Description
	2	rPP20 D 24V EFP G2	Relay Pack with 0-10V Dimming Output
	2	rPP20 D 24V EM EFP G2	Emergency Relay Pack with 0-10V Dimming Output
	2	rPODBA 2P G2	Battery Powered, 2-Pole, On/Off WallPod
	6	rCMS 6 G2	High Bay Occupancy Sensor

OPERATIONAL DETAILS:

Light Fixtures:

- All fixtures are dimmable
- Maximum level can be task tuned to any percentage via programming

Occupancy Control:

- Fixtures automatically go to full bright when occupied
- Fixtures automatically turn off or optionally can be configured to drop to low dim setting when space becomes vacant

Daylight Control:

- Daylight responsive controls lights to full off when adequate daylight present
- Not required for spaces without skylights or that have loads <150W in toplit zones

ADDITIONAL OPTIONS:

- Room can be connected to nLight backbone to enable network control or time schedules
- HVAC control available through system-wide BACnet interface option on the nLight ECLYPSE™ controller
- Wireless fixture embedded control and occupancy/daylighting sensor options available, please see the fixture specification sheet
- For emergency lighting control use a power pack with ER/EM option or nLight Enabled Fixture with emergency option

Note: Contact your local lighting agent for more information on nLight enabled fixtures.

Wireless with nLight Enabled Fixtures

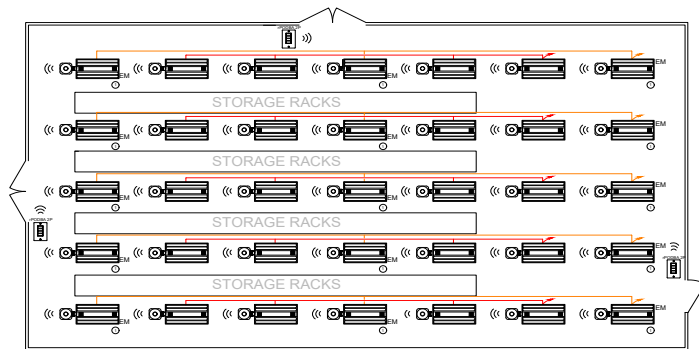

Wireless with 0-10V Dimming Fixtures

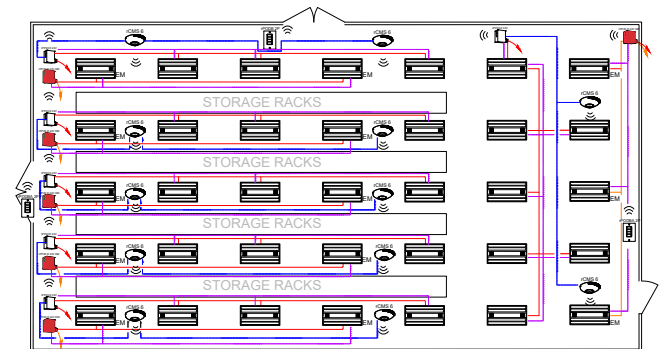

Bill of Materials

Symbol	Qty	Product #	Description
	20	See Note	nLight AIR Enabled High Bay Fixture with Sensor Option
	15	See Note	nLight AIR Enabled High Bay Fixture with Sensor and EM Option
	3	rPODBA 2P G2	Battery Powered, 2-Pole, On/Off WallPod

Bill of Materials

Symbol	Qty	Product #	Description
	6	rPP20 D 24V EFP G2	Relay Pack with 0-10V Dimming Output
	6	rPP20 D 24V EM EFP G2	Emergency Relay Pack with 0-10V Dimming Output
	3	rPODBA 2P G2	Battery Powered, 2-Pole, On/Off WallPod
	12	rCMS 6 G2	High Bay Occupancy Sensor

OPERATIONAL DETAILS:

Light Fixtures:

- All fixtures are dimmable
- Maximum level can be task tuned to any percentage via programming

Occupancy Control:

- Fixtures automatically go to full bright when occupied
- Fixtures automatically turn off or optionally can be configured to drop to low dim setting when space becomes vacant

Daylight Control:

- Daylight responsive controls lights to full off when adequate daylight present
- Not required for spaces without skylights or that have loads <150W in toplit zones

ADDITIONAL OPTIONS:

- Room can be connected to nLight backbone to enable network control or time schedules
- HVAC control available through system-wide BACnet interface option on the nLight ECLYPSE™ controller
- Wireless fixture embedded control and occupancy/daylighting sensor options available, please see the fixture specification sheet
- For emergency lighting control use a power pack with ER/EM option or nLight Enabled Fixture with emergency option

Note: Contact your local lighting agent for more information on nLight enabled fixtures.

Wireless Parking Garage

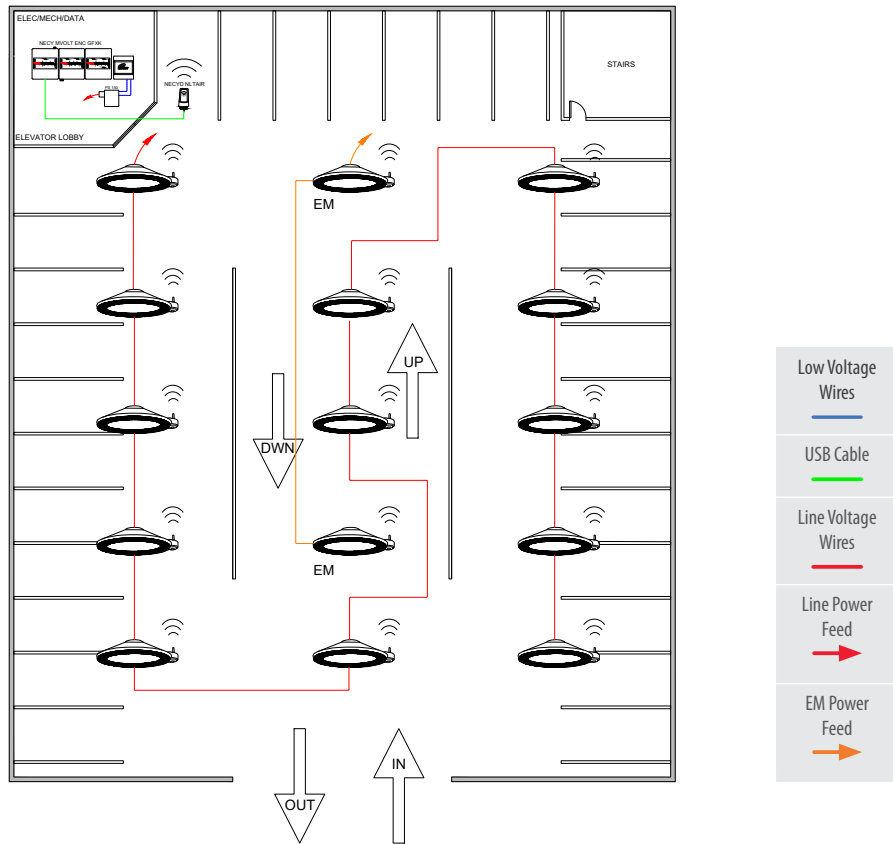

① Fixture(s) assumed to include power interruption detection emergency option. For battery backup option, no dedicated EM circuit necessary.

Bill of Materials

Symbol	Qty	Product #	Description
	13	See Note	nLight AIR Enabled Canopy Fixture with Sensor Option
	2	See Note	nLight AIR Enabled Canopy Fixture with Sensor and EM Option
	1	nECY	nLight ECLYPSE™ Network System Controller
	1	nECYD NLTAIR G2	nLight AIR Adapter

OPERATIONAL DETAILS:

Light Fixtures:

- All fixtures are dimmable
- All fixtures can be controlled together or independently
- Maximum level can be task tuned to any percentage via programming

Occupancy Control:

- Fixtures automatically go to full bright when occupied
- Fixtures automatically turn off or optionally can be configured to drop to low dim setting when space becomes vacant

Daylight Control:

- Daylight responsive controls lights to full off when adequate daylight present

ADDITIONAL OPTIONS:

- Devices can be connected to nLight backbone to enabled network control or time schedules, including astronomical time schedules for shutoff. GFKX option can be added to nLight ECLYPSE™ to provide manual override (9.4.4.1[a]).
- Wireless fixture embedded control and occupancy/daylighting sensor options available, please see the fixture specification sheet
- For emergency lighting control use a power pack with ER/EM option or nLight Enabled Fixture with emergency option

Note: Contact your local lighting agent for more information on nLight enabled fixtures.

Wireless Site Lighting

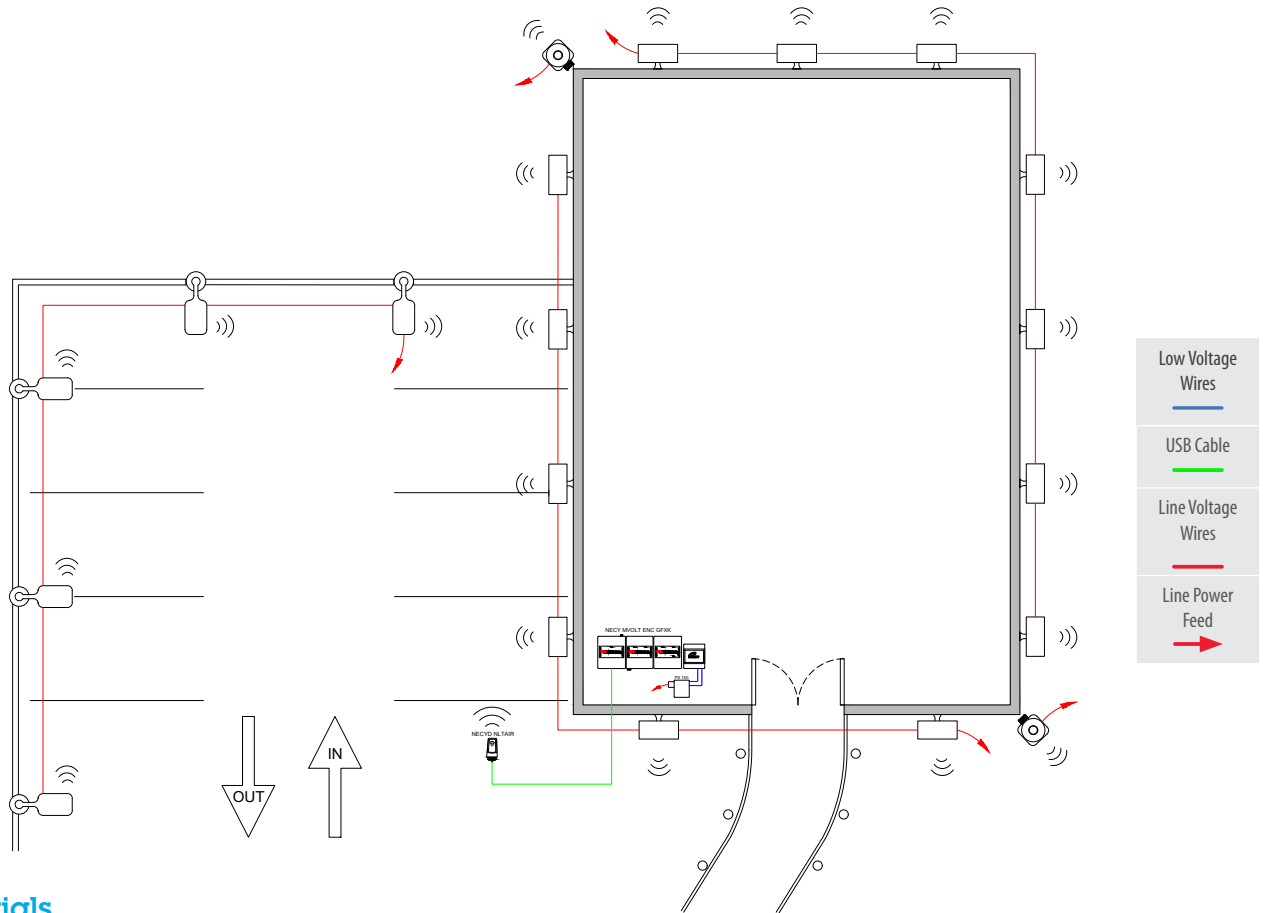

Bill of Materials

Symbol	Qty	Product #	Description
	5	See Note	nLight AIR Enabled Area Fixture
	5	See Note	nLight AIR Enabled Wall Mount
	1	nECY	nLight ECLYPSE™ Network System Controller
	1	nECYD NLTAIR G2	nLight AIR Adapter
	2	rSBOR	nLight AIR Outdoor Box Mount Sensor

OPERATIONAL DETAILS:

Light Fixtures:

- All fixtures are dimmable
- All fixtures can be controlled together or independently
- Maximum level can be task tuned to any percentage via programming

Occupancy Control:

- Fixtures automatically go to full bright when occupied
- Fixtures automatically turn off or optionally can be configured to drop to low dim setting when space becomes vacant

Daylight Control:

- Daylight responsive controls lights to full off when adequate daylight present

ADDITIONAL OPTIONS:

- Devices can be connected to nLight backbone to enabled network control or time schedules, including astronomical time schedules for lighting shutoff (9.4.1.4[b]) and lighting setback (9.4.1.4[c]). GFXK option can be added to nLight ECLYPSE™ to provide manual override (9.4.4.1[a]). Luminaires reduced to 50% when no activity is detected for 15-minutes (9.4.1.4[d]).
- Wireless fixture embedded control and occupancy/daylighting sensor options available, please see the fixture specification sheet
- For emergency lighting control use a power pack with ER/EM option or nLight Enabled Fixture with emergency option
- Outdoor nLight AIR devices (such as the rSBOR sensors shown) can repeat wireless, network messages around corners.

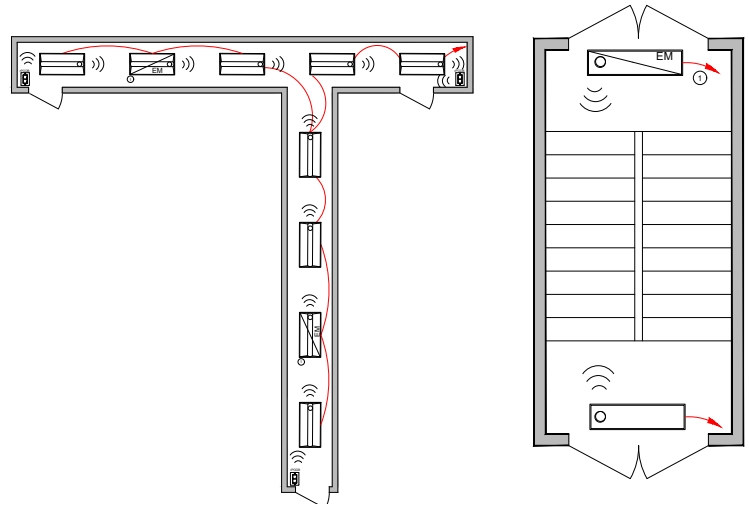
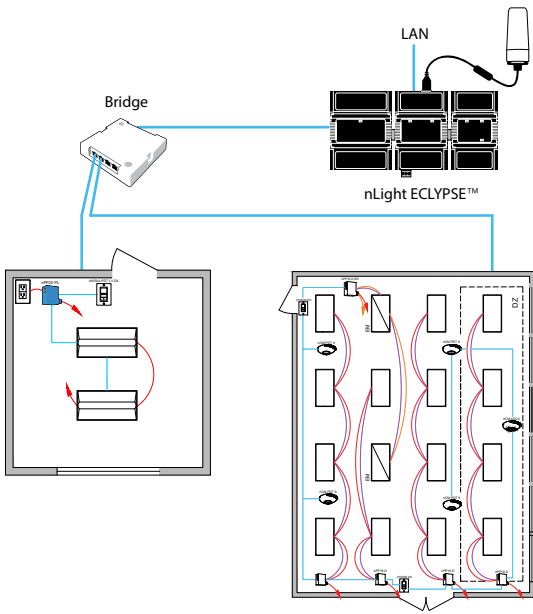

Note: Contact your local lighting agent for more information on nLight enabled fixtures.





Programmable Time Clock Control:

Although not pictured within each of the individual room design guides, each nLight controlled space can be connected via an nLight backbone to create a networked nLight lighting control system capable of meeting the requirements of ASHRAE 90.1 scheduled shutoff, provision 9.4.1.4[i]. A networked system also enables astronomical time clock control.







Bill of Materials

Symbol	Qty	Product #	Description
	1	nBRG 8 KIT	8-Port Backbone Bridge
	1	nECY MVOLT ENC	nLight ECLYPSE™ Network System Controller and Optional BMS Interface
	1	nECYD NLTAIR G2	nLight AIR Adapter

Control Requirement	Code Provision	nLight Solution Details	
Local (i.e. Switch) Control	9.4.1.1[a]	nLight WallPod devices provide a user with local control of lighting within an nLight controlled space. WallPods are available in multiple styles – each with varying features and user experiences.	
		Push-Button WallPod	Graphic WallPod*
		nPODMA Series rPODBA Series 	nLight UNITOUCH Touchscreen Wall Switch 
		Traditional tactile buttons and LED user feedback.	Full-color touch screen provides a sophisticated look and feel.
Shut-Off Control Scheduled Shutoff & Off During Non-Business Hours	9.4.1.1[i] 9.4.1.1[j] 9.4.1.4	Individual nLight control groups (i.e.: rooms) can be easily networked together across an entire building simply by connecting them into a “backbone” made up of one or more nLight bridge devices and/or nLight AIR adapters and an nLight ECLYPSE™ system controller. The system controller provides programmable time clock functionality for an nLight network as well as interfaces to the SensorView suite of web-based software applications (via an Ethernet LAN / WAN connection).	
		Network System Controller	
		Network System Controller 	
Additional benefits of installing an nLight backbone include remote status monitoring, system-wide configuration changes, optional building management system integration, and optional automated demand response through OpenADR 2.0a.			
Automatic Full OFF Via Occupancy Sensor	9.4.1.1[h]	nLight occupancy sensors utilize 100% digital passive infrared (PIR) detection, come in several mounting styles, and offer multiple coverage pattern options. Additionally, nLight sensors are available with patented Microphonics™ dual technology detection for rooms with obstructions. Configuring for full off vs. partial off control is done with system programming.	
Automatic Partial OFF Via Occupancy Sensor	9.4.1.1[g]	360° Occupancy Sensor	120° WideView Corner Sensor*
		nCM Series rCMS Series rCMSB Series 	nWV Series 
		Surface mounts to ceiling tiles or sheetrock/plaster.	Directly mounts in corner or to ceiling via repositionable ceiling bracket.

*Available with nLight Wired products only.

Note: This summary is for general information purposes only and is provided without any warranty as to accuracy, completeness, or otherwise. The user should read the applicable code sections for more complete and detailed descriptions of code requirements and exceptions and should consult with a professional engineering or other competent advisor before making any decision or taking any action based on this summary.

Control Requirement	Code Provision	nLight Solution Details	
Light Level Control	9.4.1.1[d]	<p>nLight provides multiple options for controlling continuous dimming luminaires. This allows spaces with several lighting types and technologies to be controlled together and with a common user experience.</p>	
		<p>nLight Enabled Acuity Brands Fixtures</p> 	<p>Dimming Relay Packs</p> <p>nPP16 Series rPP20 Series</p> 
		<p>Acuity Brands offers a wide variety of LED fixtures with factory installed integrated nLight controls that provide smooth continuous dimming.</p>	<p>nLight dimming relay enable control of any 0-10VDC dimmable LED luminaire.</p>
Automatic Daylight Responsive Controls for Sidelighting/ Toplighting	9.4.1.1[e] 9.4.1.1[f]	<p>nLight offers standalone daylight harvesting sensors as well as occupancy sensors with integrated daylight harvesting. Sensors are available in various housings and provide continuous dimming control of any/all networked nLight enabled fixtures or dimming relay packs, each capable of being its own daylight zone.</p>	
		<p>Ceiling Mount Dimming Photocell</p>	<p>Recessed Mount Dimming Photocell*</p>
		<p>nCM Series rCMS Series rCMSB Series</p> 	<p>nRM Series</p> 
Additional Controls	8.4.2	<p>The nLight Plug Load Relay Pack is capable of switching an entire 20A receptacle load. Simply add an occupancy sensor to an nLight Control Zone (room) and the sensor will automatically switch off when the room is vacant.</p>	
		<p>Plug Load / Receptacle Relay Pack</p>	
		 <p>nPP20 PL Series</p>	 <p>rPP20 Series</p>

nLight Enabled Fixtures

Acuity Brands offers the industry's broadest portfolio of controls enabled fixtures. Please scan the QR code to see the current nLight enabled fixtures.



nLight AIR Enabled Luminaires



nLight Wired Enabled Luminaires

Mobile Apps

Quick and Easy Lighting Configuration and Control In the Palm of Your Hand

nLight Wired



nLight BLE Radio Module

nLight wired uses the nIO BT (Bluetooth® Low Energy radio module) to communicate with the nConfig app to modify the settings and operation of the devices in an nLight zone.

nConfig™

The nConfig mobile app is for nLight wired controls startups. It's a quick and easy alternative to SensorView software for smaller projects and simple programming.

nLight AIR



CLAIRITY™ Pro

The CLAIRITY Pro mobile app allows you to start up, configure and troubleshoot nLight AIR wireless controls from a compatible smartphone or tablet.

Specification Tools

We have developed a set of productivity tools to help you do your job faster and easier. Using our easy-to-use tools, you can specify and design with confidence more quickly.

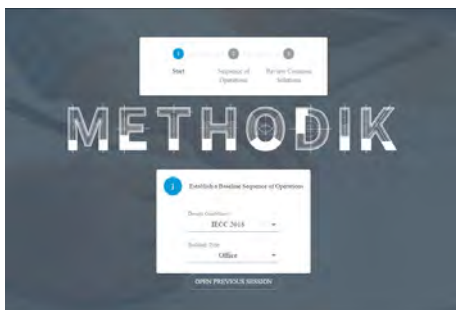

Develop Your Sequence of Operations Faster

Methodik is an online tool that generates a sequence of operations quickly, designed to save time and increase your productivity. The sequence of operations can export your project into DXF, PDF, and CSV file formats to include in your electrical set. Additionally, it gives recommendations on products that can be used in each space--fixtures and controls side by side.

Get The Tool!

<https://methodik.acuitybrands.com/#/>



Spec Builder - Build Your Spec Faster and Easier

We have developed an online tool designed to make the creation and manipulation of project specifications faster and easier.

Spec Builder includes Division 26, network lighting control specification language, as well as Division 23 and Division 25 HVAC and integration specification language.

Build Your Spec Now!

<https://www.spec.build/>



A Quicker Way to do a Design Take-Off

The Visual Controls software supports efficient design and specification with Acuity Controls. You can quickly perform a design take-off to bid a project and generate a comprehensive professional submittal.

To get access to the Visual Controls software, please contact your local lighting agent to get access today.

Get Access Now

<https://www.acuitybrands.com/support/how-to-buy>



nLight®

ASHRAE 90.1–2019 Applications Guide

In addition to being North America's leading manufacturer of indoor and outdoor luminaires, Acuity Brands offers an extensive portfolio of advanced lighting control and building technology solutions for indoor and outdoor applications, from single-room control to fully connected smart building management. Our products, technology, expertise and support include occupancy and photosensors, centralized and distributed systems, panels, luminaire-integrated wired/wireless networked controls and IoT platform services.

nLight Typical Layout Drawings

<http://www.acuitybrands.com/typicals>

ASHRAE

<https://www.ashrae.org/>

Use the Following Sections of the ASHRAE 90.1–2019 Code as Reference:

- Section 8.4.2 — Automatic Receptacle Control
- Section 9.4.1.1[a] — Local Control
- Section 9.4.1.1[b] — Manual On
- Section 9.4.1.1[c] — Partial Automatic On
- Section 9.4.1.1[d] — Bi-Level Lighting Control
- Section 9.4.1.1[e] — Automatic Daylight Responsive Control for Sidelighting
- Section 9.4.1.1[f] — Automatic Daylight Responsive Controls for Toplighting
- Section 9.4.1.1[g] — Automatic Partial Off
- Section 9.4.1.1[h] — Automatic Full Off
- Section 9.4.1.1[i] — Scheduled Shutoff
- Section 9.4.1.1[j] — Scheduled Shutoff During Non-Business Hours
- Section 9.4.1.2 — Parking Garage Lighting Control
- Section 9.4.1.4 — Exterior Lighting Control



A+ Certified solutions from Acuity Brands help you quickly and confidently select and implement lighting systems that are both compatible and consistent.

For lighting applications, A+ means verified consistent performance, visual appearance and system interoperability of all luminaires and controls within the certified solutions. For lighting professionals it means confidence that all parts of the lighting system will work together and meet common Acuity Brands specifications.

Go to www.acuitybrands.com/solutions/a-certified or contact your local Acuity Brands representative for more information.

The Bluetooth® word mark and logos are registered trademarks owned by Bluetooth SIG, Inc. and any use of such marks by Acuity Brands Lighting is under license.